

INFO EDUARD

Vol 14, January 2015

ISSUE 55



price US \$ 0.00



INFO EDUARD

ISSUE 55

© Eduard - Model Accessories, 2015

FREE FOR DOWNLOAD, FREE FOR DISTRIBUTION!

This material may only be used for personal use. No part of the text or graphic presentations can be used in another publication in any other media form or otherwise distributed without the prior written permission of Eduard - Model Accessorie and authors involved.

Editorial and Graphics - Marketing department, Eduard - Model Accessories, Ltd.

January 2015

CONTENTS

EDITORIAL - 4

KITS - 8

Bundersfighter 1/48, Bf 110C 1/72,
Albatros D.Va 1/48, F6F-5 late 1/48

BRASSIN - 13

PHOTO-ETCHED SETS - 17

BIG ED - 23

RELEASES - 24

January 2015

BUILT - 25

Avia B.534 1/72
AGM-12C Bullpup B 1/48
AGM-78 Standard ARM 1/48
SSW D.III 1/48

ON APPROACH - 28

February 2015

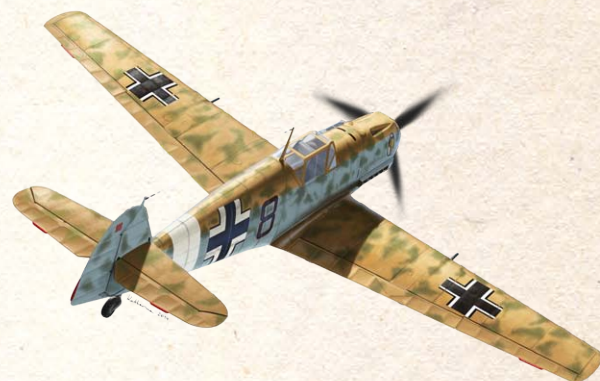
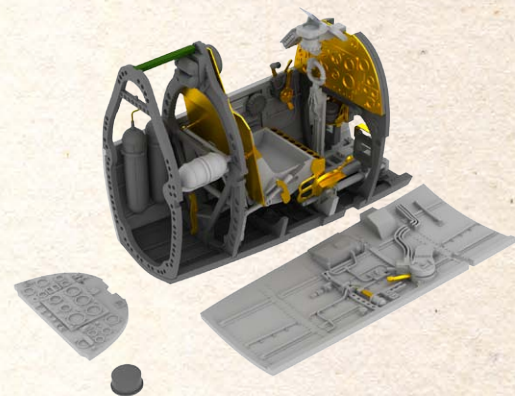

EDITORIAL

Dear Friends,

Here we are in the New Year and at a new beginning. The last year was an eventful one, many things worked out well, others did not, and what did not will be made right this year. The main topic of discussion that falls into the latter category was the Bf 109G project, which we temporarily suspended after a wave of criticism and our decision to rework the model. The rework is nearing completion. Aside from the overall dimensions of the kit, which was the base problem of the original, we also revisited some other aspects of the kit. The wing to fuselage fairing has been modified to correspond with that most often seen on the G-6 variant. We redesigned the rear part of the fuselage behind the cockpit to address criticism levied against the fuselage outline at about the second former after the canopy. While we were at it, we modified the progression of the individual fuselage segments to better represent the appearance of the real thing. We did the same through to the front of the aircraft. We re-measured the whole thing, systematically photographed it and, last but not least, we got down and dirty with it prior to redesigning the kit. None of this was a particularly simple affair, but the end result is more than interesting and I am certain that most modelers will be rather pleasantly surprised. I am looking forward to releasing the information surrounding this updated effort, including details of the study of the real McCoy, via our now typical and sometimes controversial marketing campaign.



There will be much to explain, the result will raise eyebrows, will be fresh and will be effective. Realistically, I expect to release this puppy in the fall, likely with an E-day premiere.

Last year I mentioned a forthcoming revolution in 1/72nd scale, and the time has come. It will be here as early as February, in the bloodless and non-violent form of the Royal Class Avia B.534. Part of the revolution will encompass the release format for kits in 1/72nd scale, where after the release of the Royal Class boxing, we will issue the Weekend Edition item prior to releasing the ProfiPACK kit. The next step will be a more intensive release schedule of new 72nd scale kits, and also re-editions of older models. Included in the development of the new kits are the UTI MiG-15, Spitfire Mk.IX/VIII and XVI, and the

Fw 190A-5/A-8/F-8. These kits, except for the UTI MiG-15, are downscaled from their respective 1/48th scale kits, but are significantly modified to reflect the difference in scale and, while maintaining a high level of detail, to not complicate their assembly. Each kit will be accompanied by the availability of new photoetched detail and Brassin resin sets. Our goal is to bring to the market high quality

1/72nd scale kits at a reasonable price. There will be the odd deviation from the release schedule template, and in the case of the Spitfire Mk.IX, it will be out first with a 'The Boys are Back' kit, copying the same format as in 1/48th.

With respect to kits in 1/48th scale, besides the above mentioned Bf 109G, this year will see a continuation of the Spitfire line, with the Spitfire Mk.VIII and Mk.XVI. The first ProfiPACK kit will see the light of day in March. The kit will be significantly modified and will not be a simple conversion of the Mk.IX. The kit contains a new fuselage and wings along with a list of new fine details, such as all-new landing gear. A feature of the kit will be the inclusion of the extended wing tips for high altitude performance. This will be followed by a Limited Edition kit covering the Spitfire Mk.VIII in Australian service and will include a publication dedicated to the kit theme. The Spitfire Mk.XVI is anticipated in the fall. This will also incorporate a new fuselage with a bubble canopy but will also include the classic fuselage with a raised spine and standard cockpit.

Another new 48th scale kit will be the SE-5a. It's the next in our Great War line and this kit was well worth the extra effort. This kit will satisfy the most demanding fan of the type, and the level of detail approaches extreme. It represents our current peak of WWI subjects and the fact that we put a lot of effort into it shows. The SSW D.III was outsourced and unfortunately it shows, and so



Spitfire Mk.VIII 1/48



Bf 109E-7 trop 1/48

we will be doing the SE-5a ourselves. Guess you reap what you sow....

We are also working on a new 1/144 scale kit, but because this will be the price of admissions kit for E-day, 2015, the subject matter won't be released anytime soon. So we don't run into the same wall as we did with last year's MiG-15, we are working on the new project now. But, all being said, the MiG ended well, didn't it? It surpassed my own expectations. And that goes for both scales....1/72 and 1/144. We will continue to release kits of the family in 1/144 with the next one slated to be the MiG-15bis in February.

Turning our attention to Limited Edition kits, January sees the release of the first Starfighter, under the name 'BUNDESFLIEGER' and covers the F-104G in the colors of the Luftwaffe. This will be followed up with two more kits, the first one also of the F-104G but in the services of European nations in NATO, and the second one will be the Japanese F-104J which we expect to accompany with a theme related publication. I probably don't need to mention that the plastic in these kits hails from Haswagawa. This year, we will also continue on with the Phantoms using Academy's kit released as a 'Good Evening, Da Nang!' boxing, focusing on the F-4C/D of the USAF. This will be followed up by the F-4J at the end of the year. In co-operation with Hasegawa, we are planning a third Limited Edition package using their A-4 in 1/48th scale. The version is not certain at this point, but will most likely be the early A-4E/F used in Vietnam. That covers the Limited Edition plans for 2015. To be continued....

This year, we will initiate at least two new projects in 1/48th scale and two in 1/72nd, one of which will be the long-awaited MiG-21.

No major changes are in the works in terms of photoetched and Brass releases. We will be focusing on getting all we can out of our new etching capa-

bilities including the etching of steel to include in our lineup. We will be endeavoring to make our resin bits easier to put together and to make the instructions clearer....a seemingly simple task. Every year at this time I usually outline our results from the previous year. Unfortunately, I received the detailed year-end stats with a slight delay, and so this information will have to wait until February's newsletter. For now, I can report that with just under 100 million crowns in sales, this was the most successful year in our history.

As usual, we will be attending Nuremberg from January 28th. If you are in

the neighborhood, we'd love to see you at our booth in Hall 7. This year's E-day will be at the same venue at Butovice on September 27 and 28, 2015. With respect to the first show of the year, that will be the Panther's Cup in Prosek.

In closing, my friends, I wish you a successful and healthy 2015, and a good read within this newsletter!

Happy Modeling!
Vladimir Sulc

Avia B.534 1/72



Avia B.534



TEST BUILT, built by Vladimír Šulc

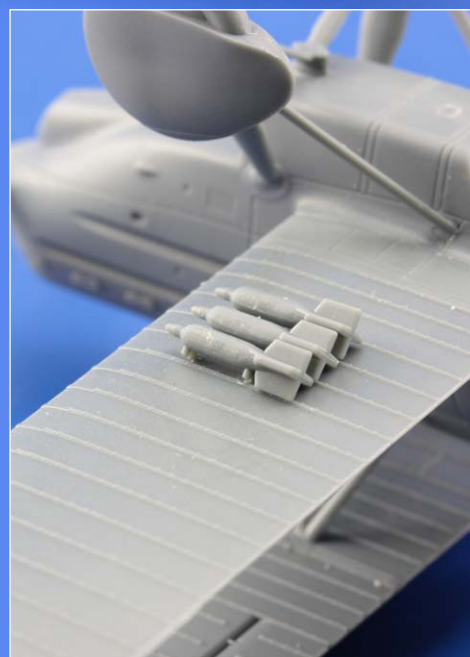

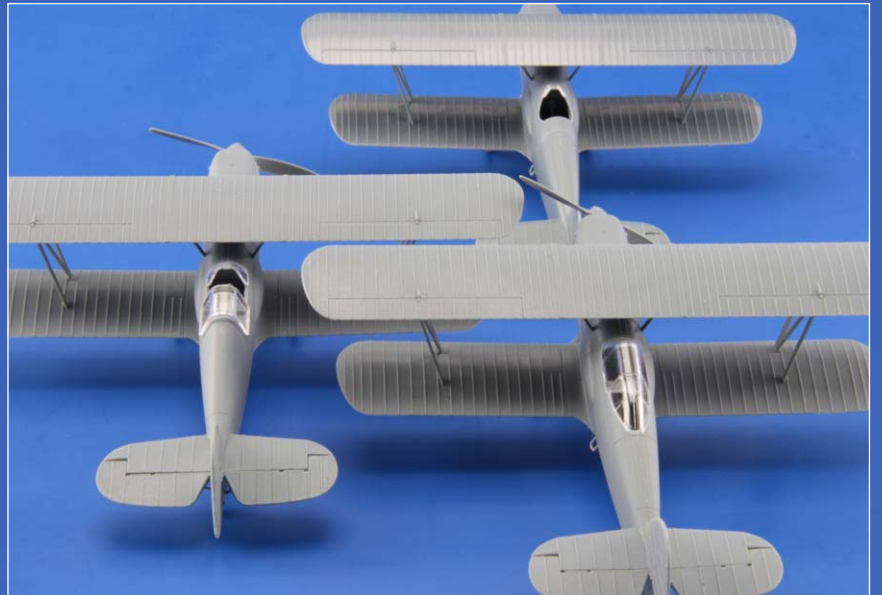
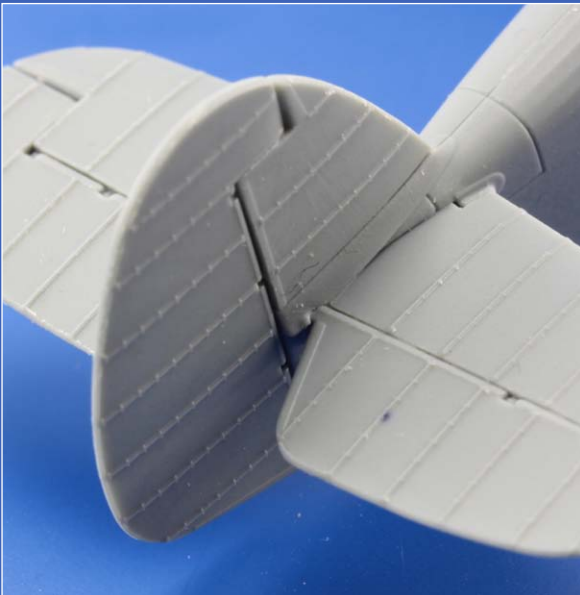

KITS

1/48, Cat. No. 1195



Bundesfighter

1/48

- ✦ F-104G in the Bundesluftwaffe service
- ✦ Hasegawa plastic parts
- ✦ 5 markings
- ✦ Cartograf decals
- ✦ Eduard Brassin seats (2 types)

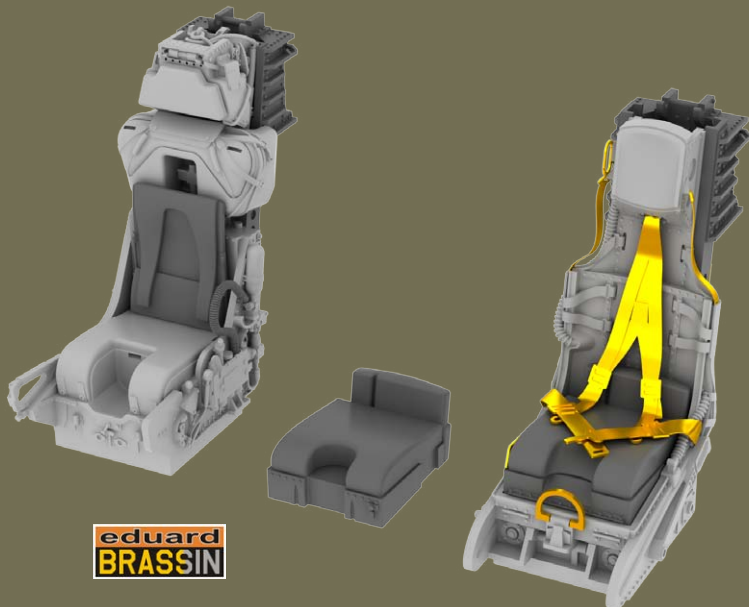

eduard
BRASSIN

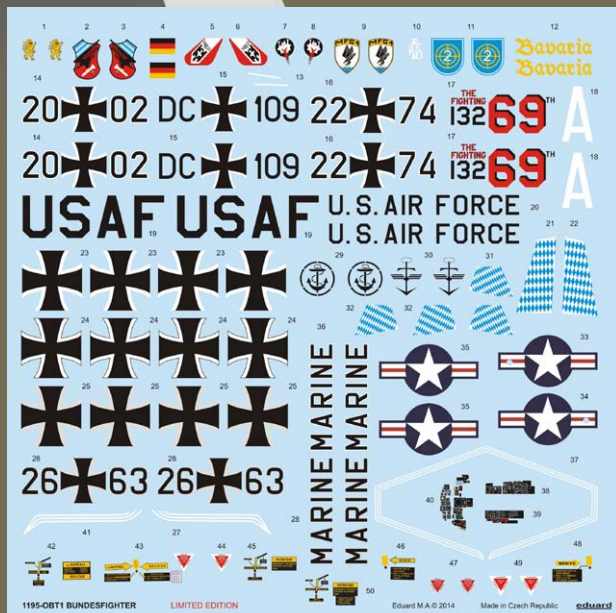

BUY Bundesfighter 1/48 



JaboG 32, Tactical Air Meet 80, June 1980

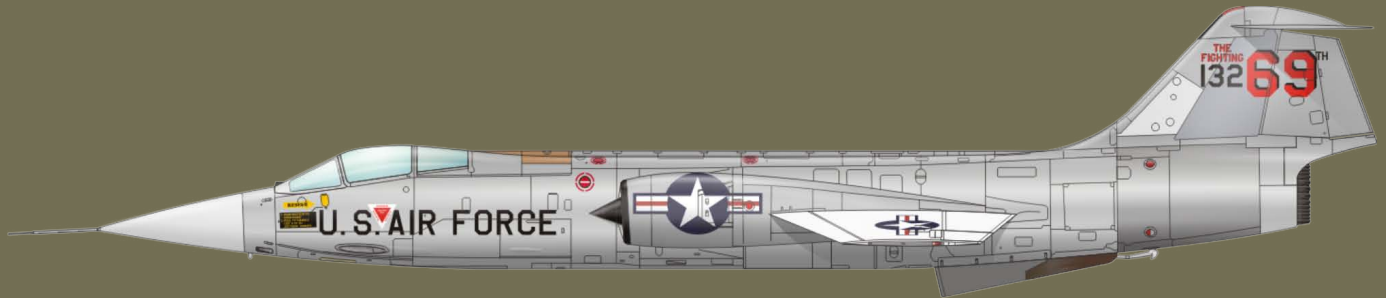

s/n 63-13269, 58th CTTW, Luke airbase, U.S.A., 1982



JaboG 33, základna Decimomannu, Sardinie, 1964

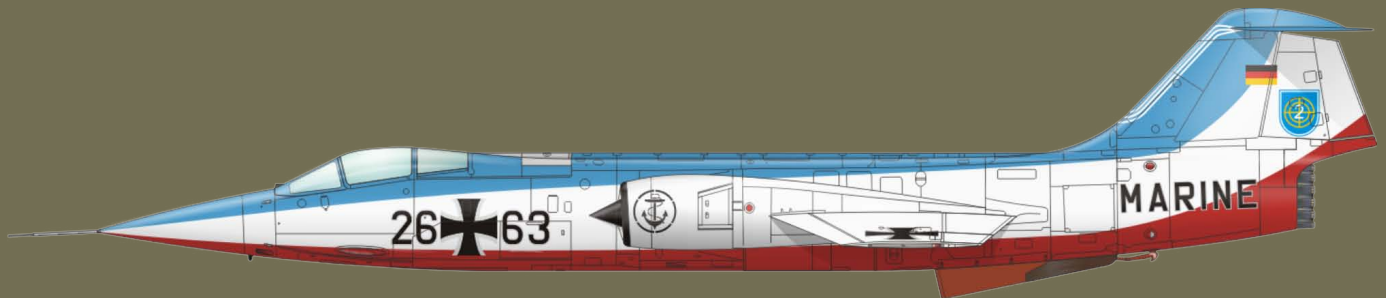

Marinefliegergeschwader 2, September 1986



Marinefliegergeschwader 1, Hannover Airport, 1980

ProfiPACK 1/48
edition

Cat. No. 8111

Albatros D.Va

- 4 markings
- photo-etched set
- Eduard decals

BUY Albatros D.Va 1/48



6550/17, Hans von Hippel, Jasta 5, Cappy sur Somme airbase, May, 1918

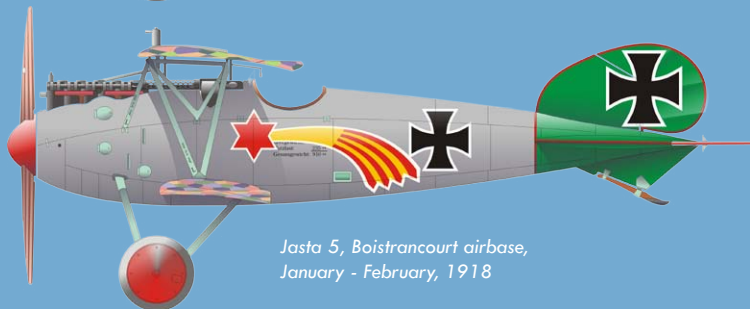

Jasta 5, Boistrancourt airbase, January - February, 1918



6633/17, Michael Sigmann, Jasta 78b, April - August, 1918



von Hunoldstein, Jasta 14, 1918

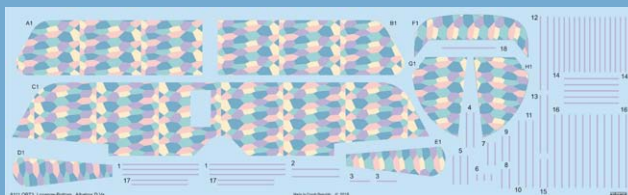
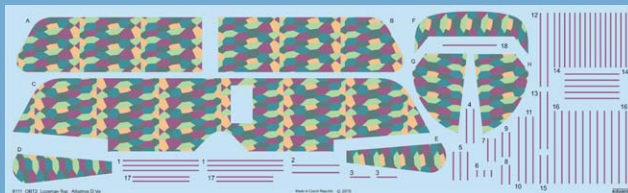



- 4 markings
- photo-etched sets
- Eduard decals
- Resin wheels

F6F-5 late

ProfiPACK 1/48
edition

Cat. No. 8224

BUY F6F-5 late 1/48



White 115, 'Death and Destruction', BuNo 72534, ENS Donald McPherson, Bill Kingston, Jr., a Lyttleton Ward, VF-83, USS Essex, 5th May, 1945

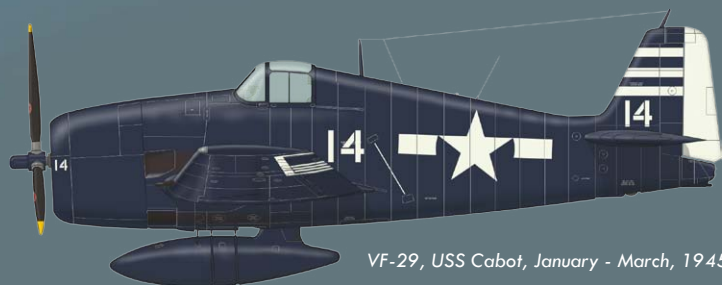

VF-29, USS Cabot, January - March, 1945

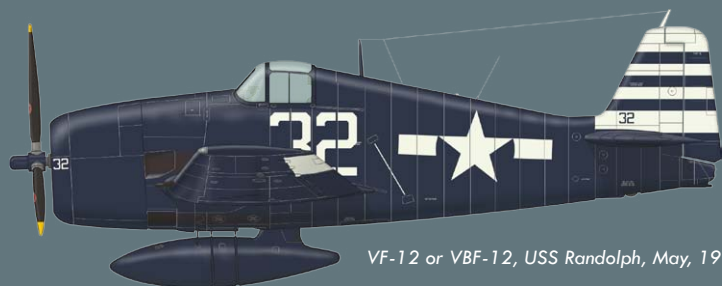

VF-12 or VBF-12, USS Randolph, May, 1945



LCDR T. Hugh Winters, Jr., VF-19, USS Lexington, late October, 1944

RECOMMENDED:

648056 R-2800-10 engine (Brassin)

648061 HVAR rockets (Brassin)

648086 US 250lb bombs (Brassin)

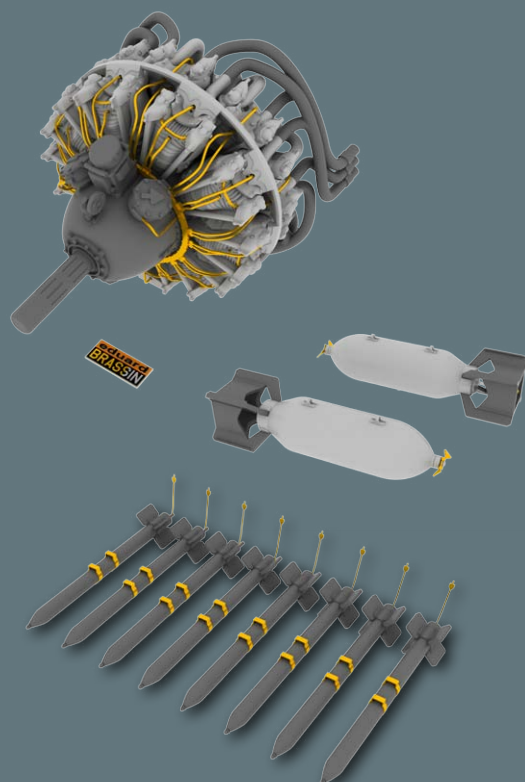

Bf 110C

1/72, Cat. No. 7426

WEEKEND
edition



- 2 markings
- SUPERFABRIC seatbelts

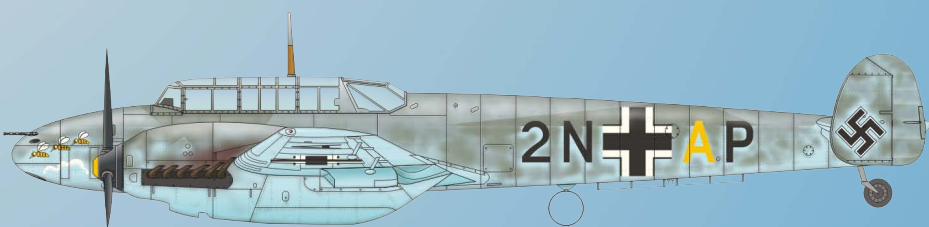
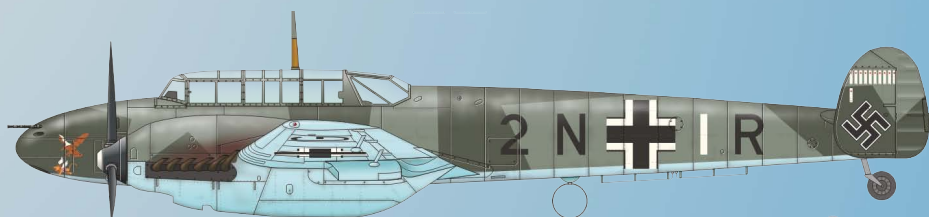
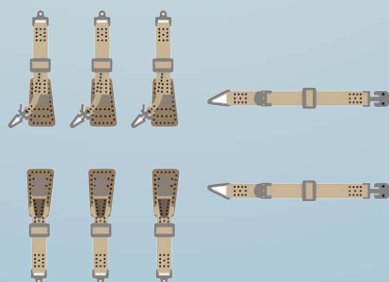

[BUY Bf 110C 1/72](#)

RECOMMENDED:

- 672010 Bf 110C/ D nose guns (Brassin)
- 672006 Bf 110C/ D wheels (Brassin)
- 672005 DB 601A/ N for Bf 110C/ D/E
- 73469 Bf 110C/ D Weekend (PE-set)
- 72555 Bf 110C/ D (PE-set)
- CX407 Bf 110C (mask)

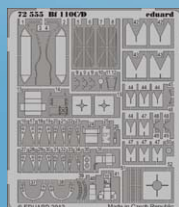
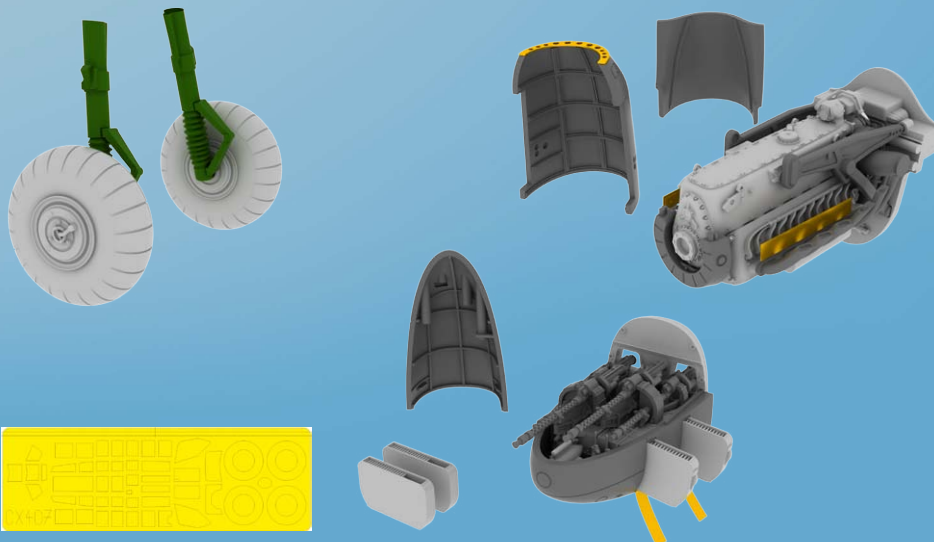

648174
F-104 exhaust nozzle early
1/48 Hasegawa

Early type of exhaust nozzle for F-104 in 48th scale by Hasegawa. This Brassin set contains three resin parts. Set also contains photo-etched details.

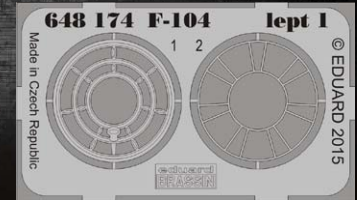

BUY F-104 exhaust nozzle early 1/48

648175
F-104 exhaust nozzle late
1/48 Hasegawa

Late type of exhaust nozzle for F-104 in 48th scale by Hasegawa. This Brassin set contains three resin parts and photo-etched details.

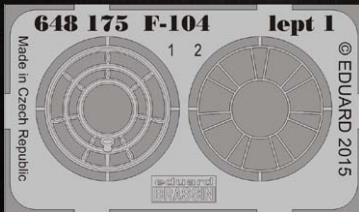

BUY F-104 exhaust nozzle late 1/48

648176
F-104 undercarriage wheels early
1/48 Hasegawa

Early type of wheels for F-104 in 48th scale by Hasegawa. Brassin set contains main landing gear wheels, front wheel and painting mask.

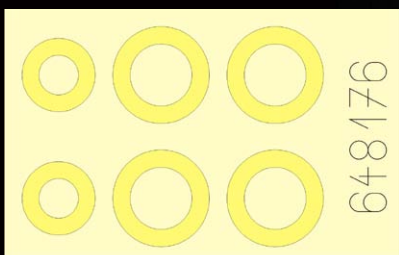

BUY F-104 undercarriage wheels early 1/48

648181
F-104 undercarriage wheels late
 1/48 Hasegawa

Late type of wheels for F-104 in 48th scale by Hasegawa. Brassin set contains main landing gear wheels, front wheel and painting mask.

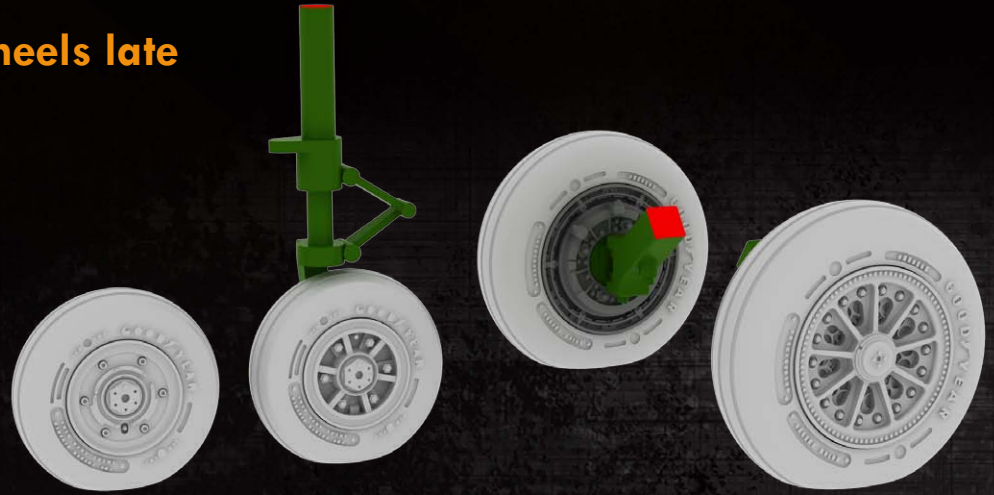
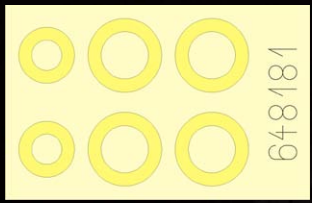

BUY F-104 undercarriage wheels late 1/48

672054
AGM-88 HARM
 1/72

Brassin set of AGM-88 HARM rockets in 72nd scale. Set contains 2 pieces of rockets and includes decals and photo-etched details.

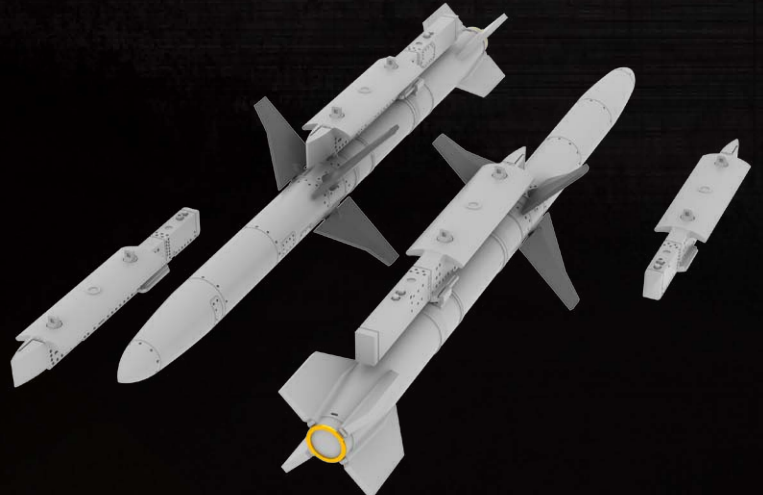
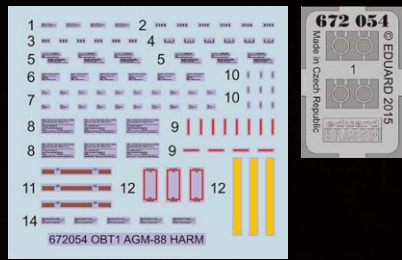

BUY AGM-88 HARM 1/72

648180
AGM-88 HARM
 1/48

Brassin set of AGM-88 HARM rockets in 48th scale. Set contains 2 pieces of rockets and includes decals and photo-etched details.

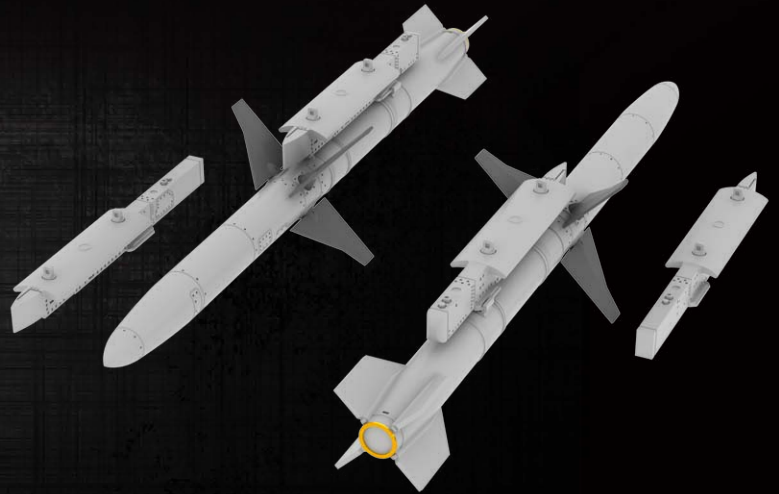
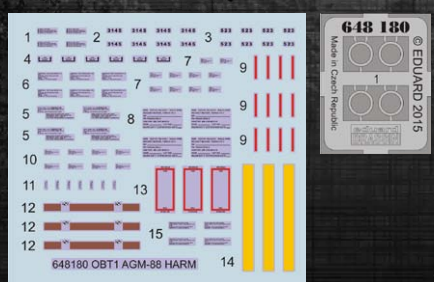

BUY AGM-88 HARM 1/48

648183 Spitfire Mk.V cockpit 1/48 Airfix

Complete cockpit for Airfix Spitfire Mk.V in 1/48 scale.

Brassin set consist of separate floor, seat, sidewalls, instrument panel, three fuselage bulkheads, oxygen bottles and many other accessories.

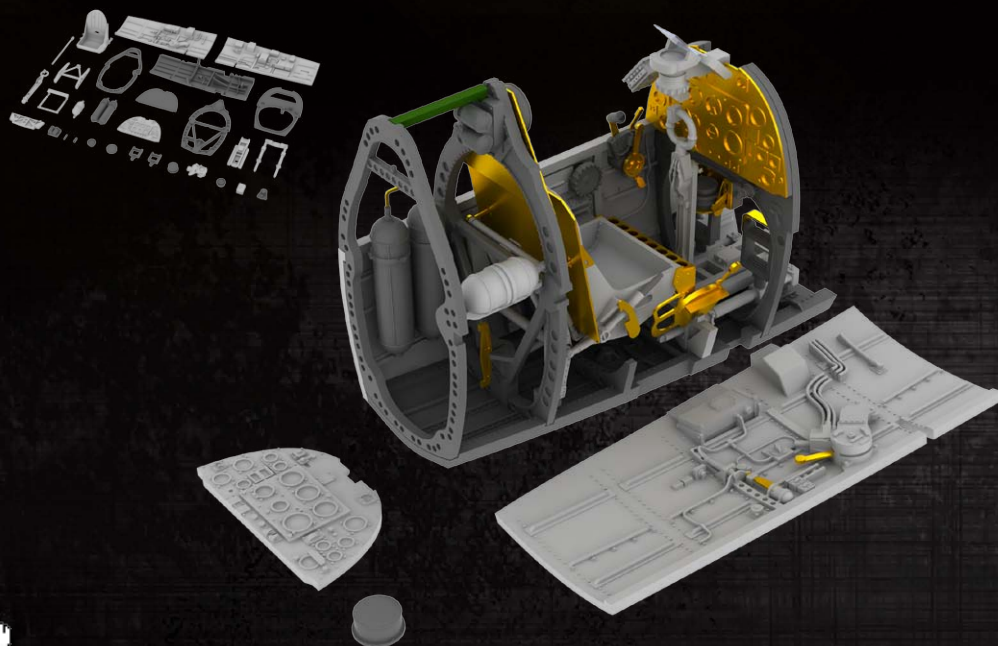
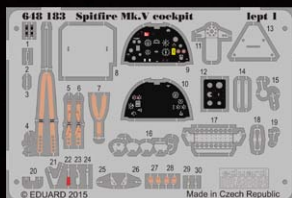

[BUY Spitfire Mk.V cockpit 1/48](#)

648184 Spitfire Mk.V radio compartment 1/48 Airfix

Brassin set of radio compartment for Spitfire Mk.V by Airfix in 48th scale. This set consists of the radio, its supports assembly, fuselage doors and fuselage insets with detailed interior structure.

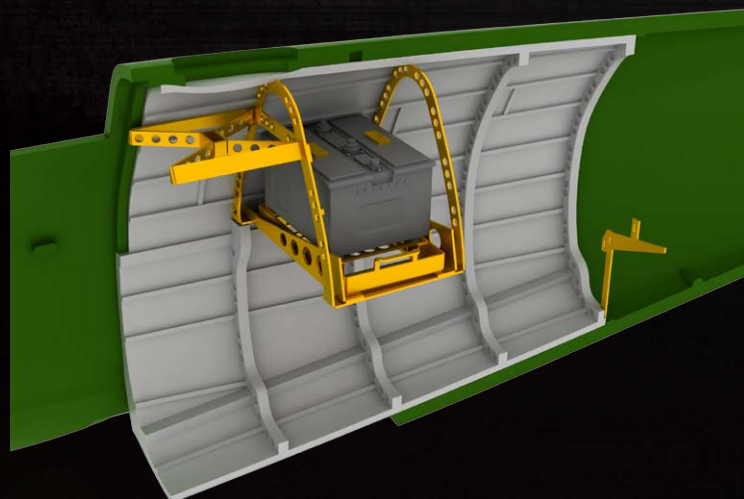
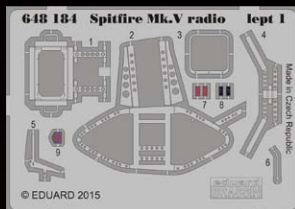

[BUY Spitfire Mk.V radio compartment 1/48](#)

648188 M 117 bomb early 1/48

Brassin set of 6 pieces of M 117 bombs (early version) in 48th scale. Decals included.

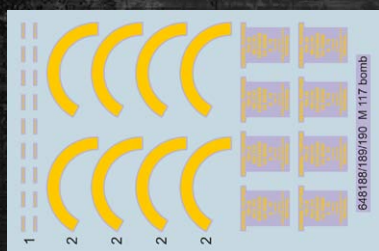

[BUY M 117 bomb early 1/48](#)

632042

Do 335B wheels

1/32 HK Models

Brassin set of Do 335B wheels in 32nd scale for Hong Kong Models kit.

Brassin set contains main landing gear wheels, front wheel and painting mask.

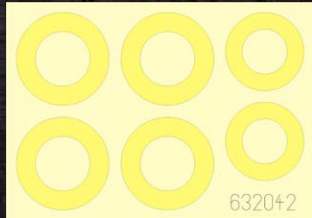

BUY Do 335B wheels 1/32 

SIN64817

F-104 WEAPONS SET

1/48

Generic BIG SIN collection containing 5 individual Brassin sets of weapons for F-104 in 48th scale.

- AIM-9B Sidewinder,
- AIM-7E Sparrow,
- Mk.82 bomb w/airbrake,
- AGM-12 Bullpup A,
- M 117 bomb early.

All sets included in this BIG SIN are available separately, but with every BIG SIN set you save up to 30%.



BUY F-104 WEAPONS SET 1/48 

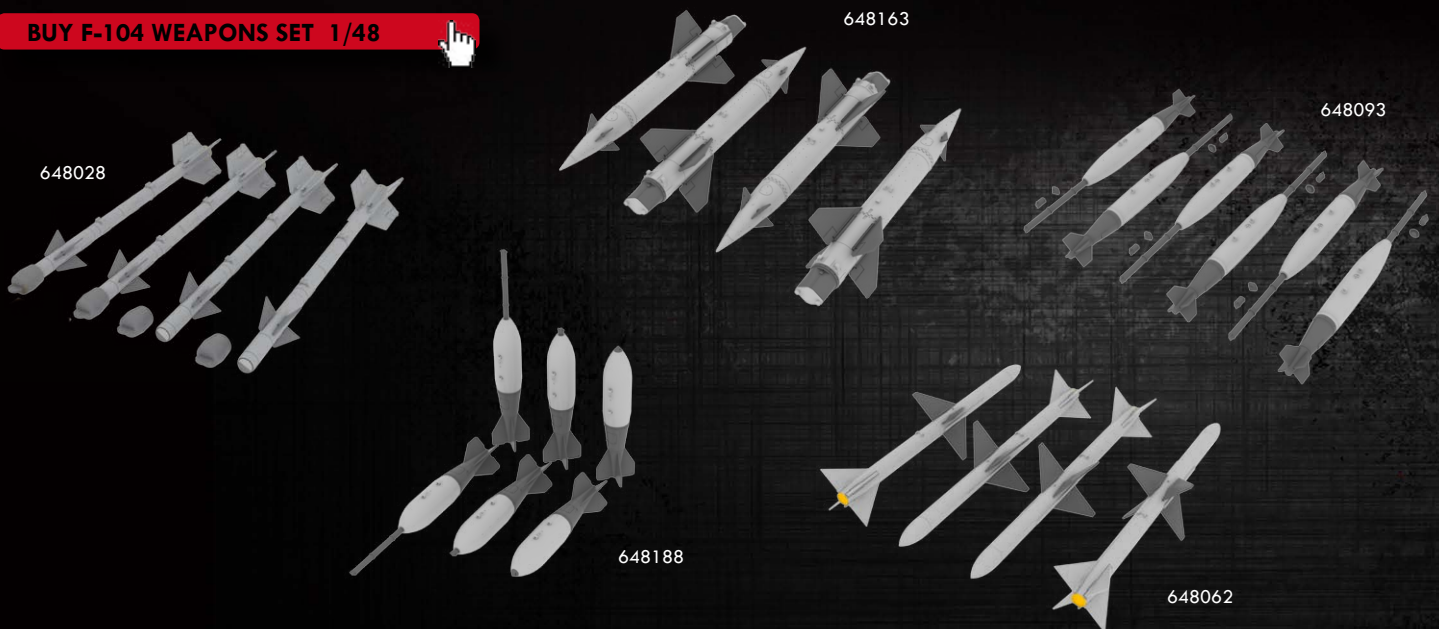
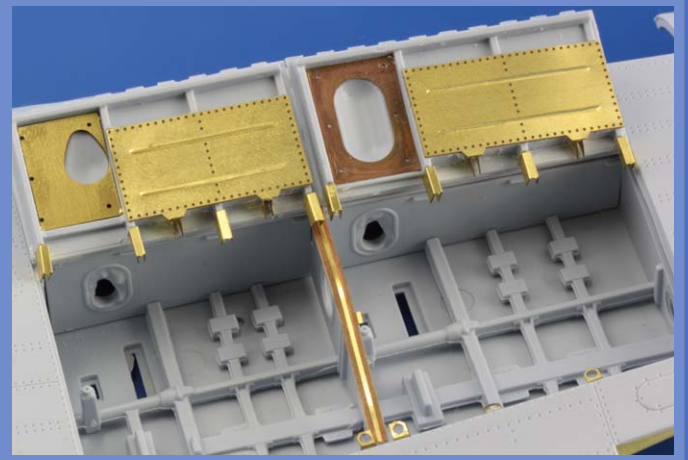

PHOTO-ETCHED SETS AND MASKS

SELECTED

Typhoon Mk.Ib wing armament 1/24 Airfix (23021)



M103A1 Heavy Tank 1/35 Dragon (36288)



Sherman Mk.V Firefly 1/35 Tamiya (36300)

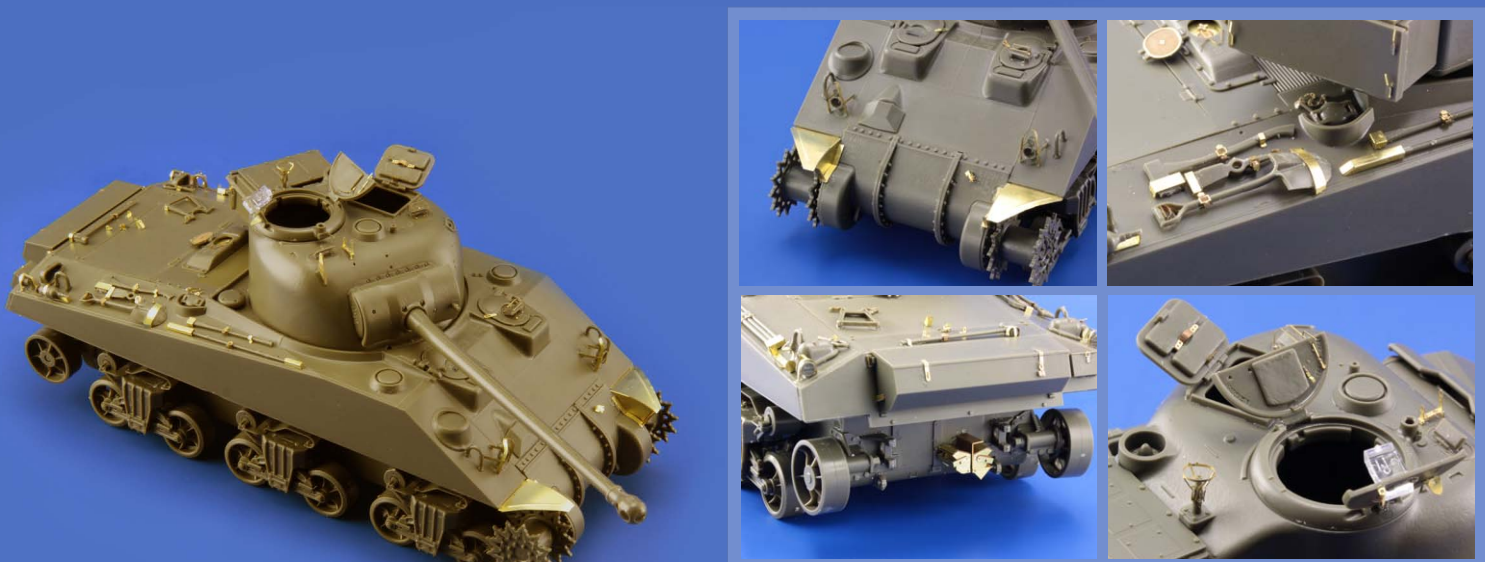

PE-SETS AND MASKS

M4A3E8 Sherman 1/35 Tamiya (36301)

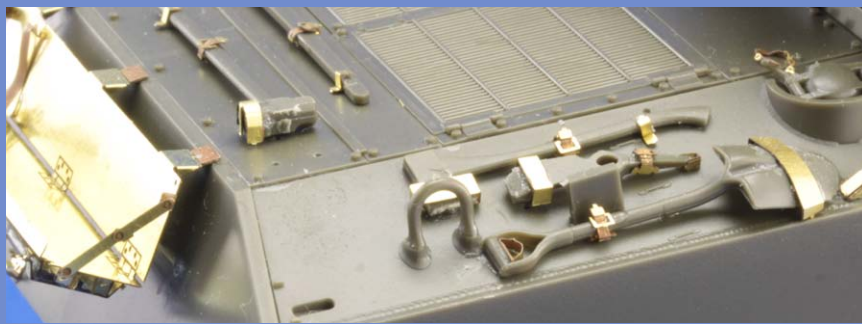
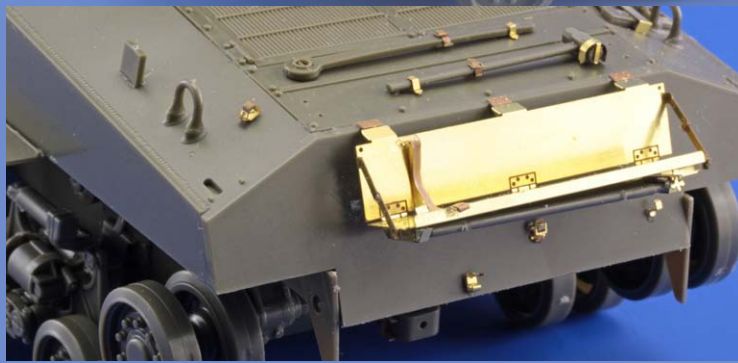

Mark IV male exterior 1/35 Tamiya (36302)

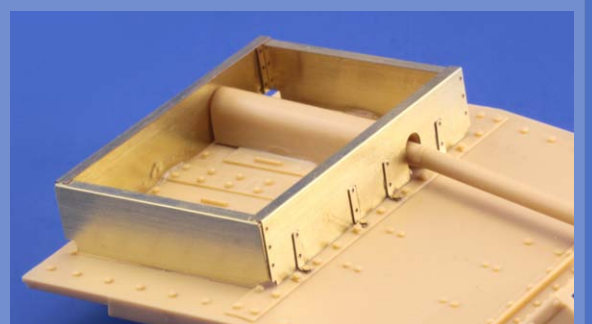
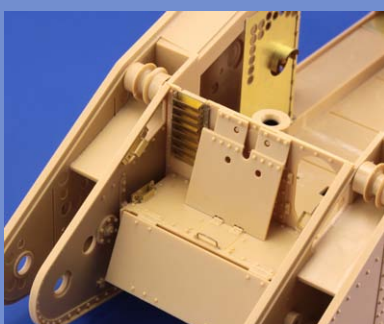

Mark IV male interior 1/35 Tamiya (36303)



T-90A 1/35 Meng (36305)



PE-SETS AND MASKS

Whirlwind exterior 1/48 Trumpeter (48830)

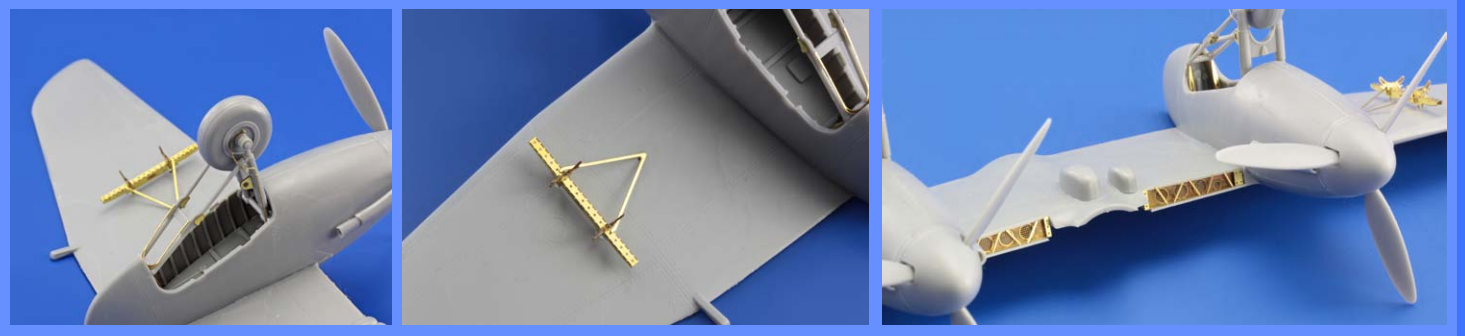

P-61B undercarriage 1/48 Great Wall Hobby (48831)

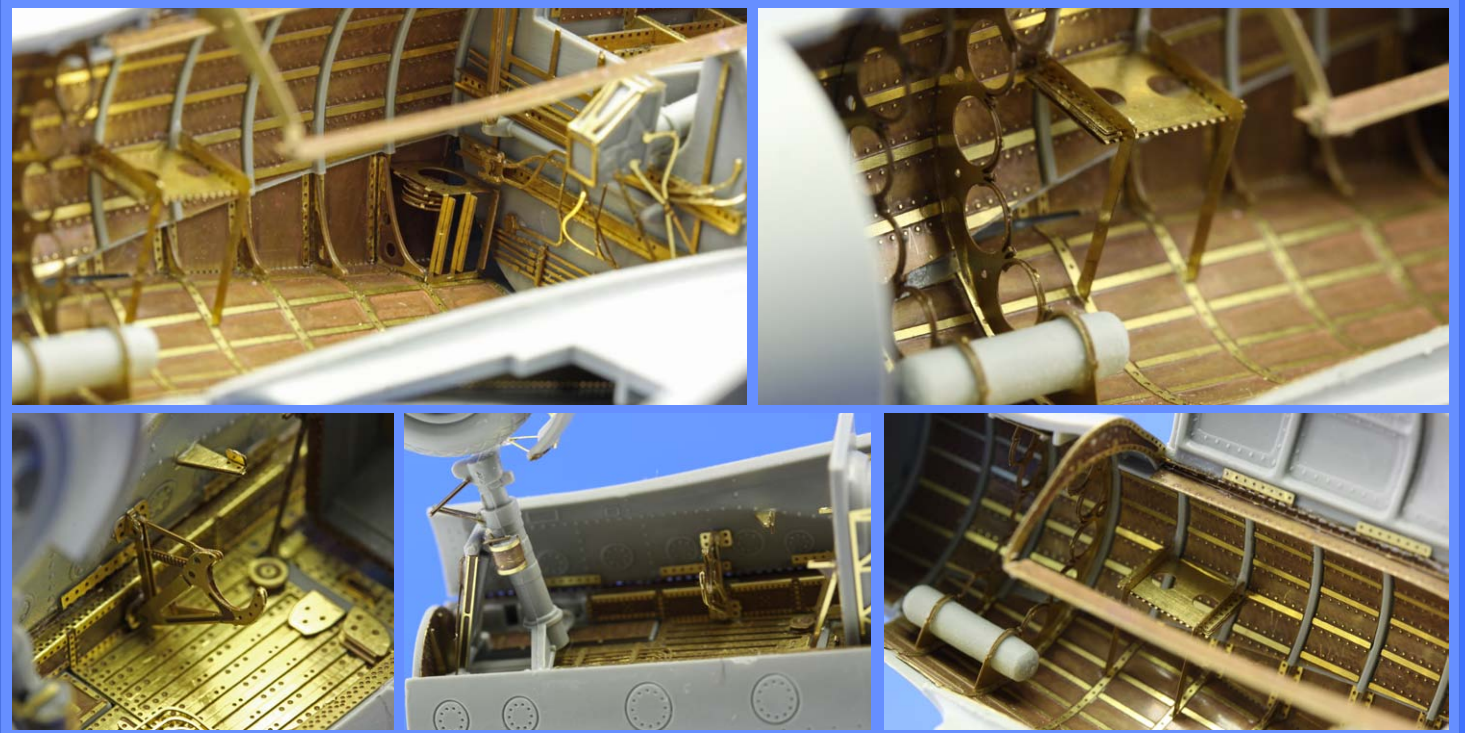

DB-3F/II-4 1/48 Xuntong Model (49700)

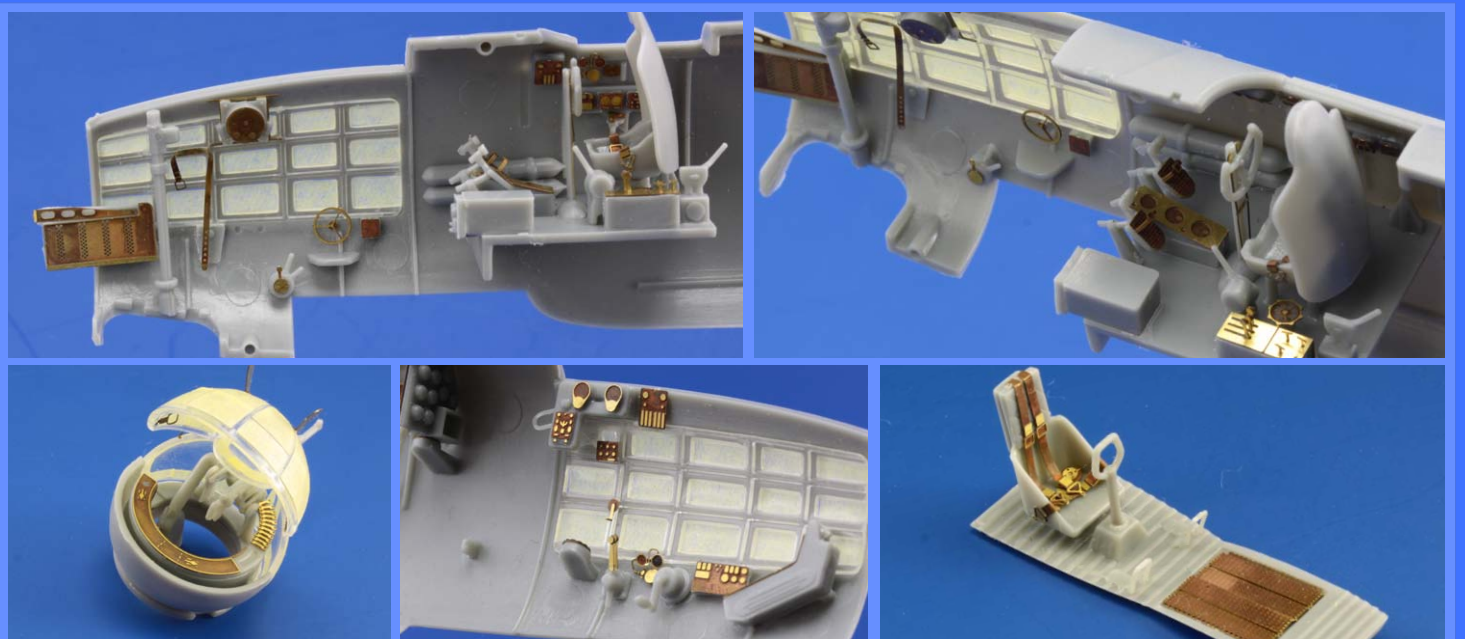

Whirlwind S.A. 1/48 Trumpeter (49701)



A-37A S.A. 1/48 Trumpeter (49702)



P-61B rear interior S.A. 1/48 Great Wall Hobby (49703)

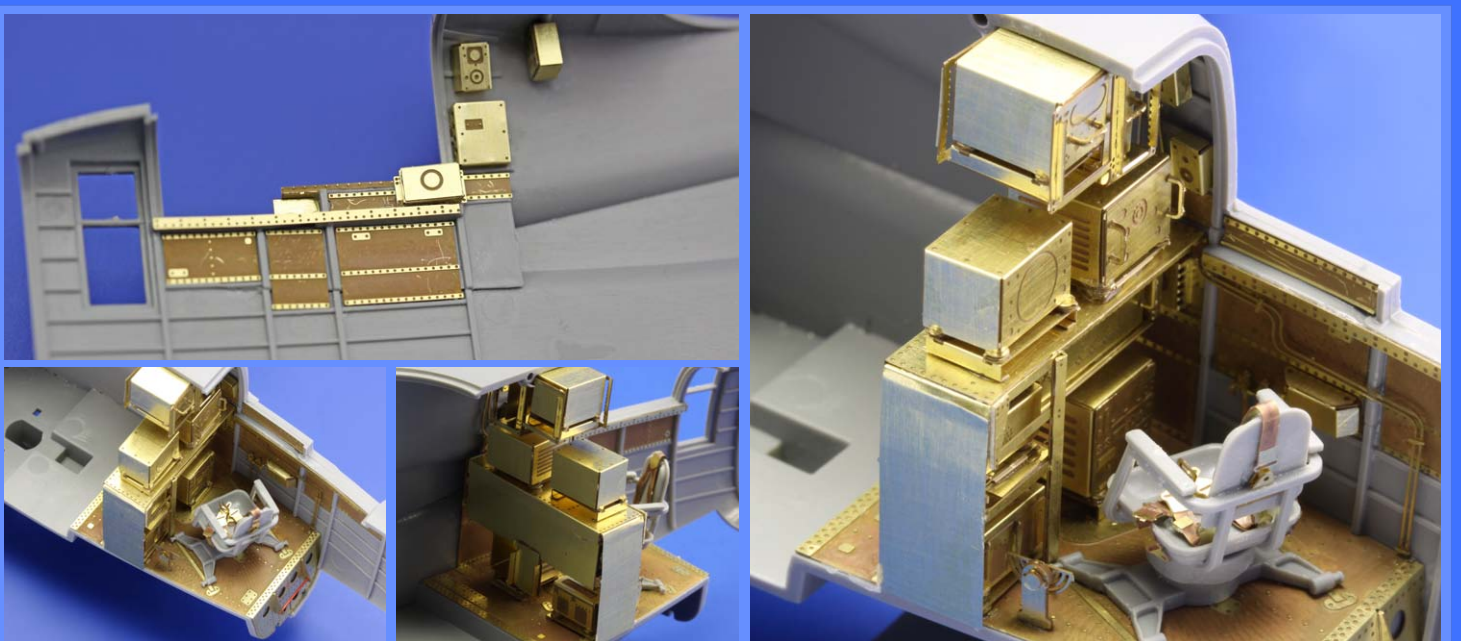

PE-SETS AND MASKS

P-61B front interior S.A. 1/48 Great Wall Hobby (49704)



Me 262B-1a S.A. 1/48 Hobby Boss (49705)



All sets included in this BIG ED are available separately, but with every BIG ED set you save up to 30%.

BIG ED



32363 F-104C exterior (BIG3347)



72587 C-47 exterior (BIG49114)



72589 Blenheim Mk.I exterior (BIG7291)

BIG3347 F-104C - PART II. 1/32 ITALERI

- 32363 F-104C exterior
- 32820 F-104C electronic equipment
- 32822 F-104C gun bay

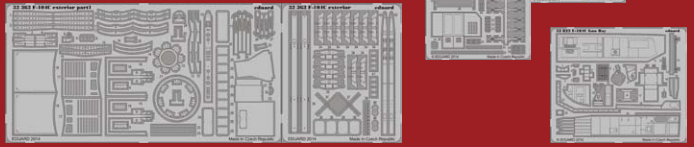

BIG49113 MiG-21R 1/48 EDUARD

- 48704 MiG-21 ladder
- 48790 MiG-21 PFM accessories
- 48794 MiG-21R exterior
- EX337 MiG-21MF
- FE692 MiG-21R Weekend



BIG49114 S-30M-2 FLANKER 1/48 ACADEMY

- 48821 S-30M-2 Flanker exterior
- 49694 S-30M-2 Flanker interior S.A.
- EX437 S-30M-2 Flanker

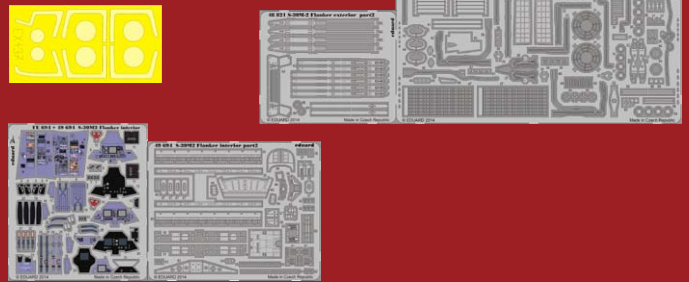

BIG7290 C-47 1/72 AIRFIX

- 72587 C-47 exterior
- 72588 C-47 landing flaps
- 72590 C-47 surface panels
- 73513 C-47 interior S.A.
- 73514 C-47 cargo seatbelts
- CX401 C-47

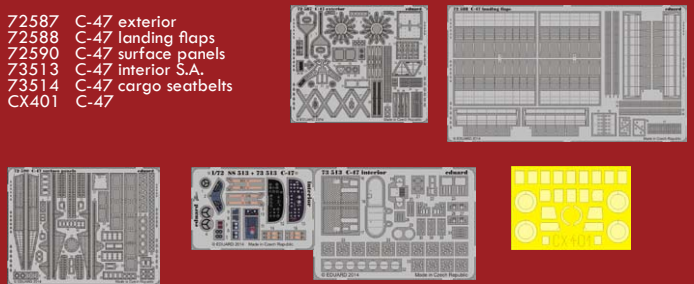

BIG7291 BLENHEIM Mk.I 1/72 AIRFIX

- 72589 Blenheim Mk.I exterior
- 72591 Blenheim Mk.I landing flaps
- 72592 Blenheim Mk.I bomb bay
- 73512 Blenheim Mk.I interior S.A.
- CX398 Blenheim Mk.I

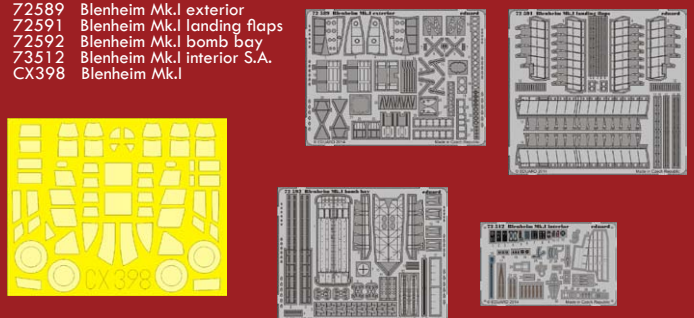

BIG3347 F-104C - PART II. 1/32 ITALERI

BIG49113 MiG-21R 1/48 EDUARD

BIG49114 S-30M-2 FLANKER 1/48 ACADEMY

BIG7290 C-47 1/72 AIRFIX

BIG7291 BLENHEIM Mk.I 1/72 AIRFIX

RELEASES JANUARY 2015



KITS

1195	Bundesfighter	1/48	Limited Edition
7426	Bf 110C	1/72	Weekend
8111	Albatros D.Va	1/48	ProfiPACK
8224	F6F-5 late	1/48	ProfiPACK

PHOTO-ETCHED SETS

23021	Typhoon Mk.Ib wing armament	1/24	Airfix
32825	Do 335B interior S.A.	1/32	Hong Kong Models
32826	Do 335B seatbelts	1/32	Hong Kong Models
36288	M103A1 Heavy Tank	1/35	Dragon
36300	Sherman Mk.V Firefly	1/35	Tamiya
36301	M4A3E8 Sherman	1/35	Tamiya
36302	Mark IV male exterior	1/35	Tamiya
36303	Mark IV male interior	1/35	Tamiya
36304	BMPT Terminator	1/35	Meng
36305	T-90A	1/35	Meng
48830	Whirlwind exterior	1/48	Trumpeter
48831	P-61B undercarriage	1/48	Great Wall Hobby
48832	F-15C MSIP II exterior	1/48	Great Wall Hobby
48833	F-104G upgrade set	1/48	Eduard/Hasegawa
49072	F-104G seatbelts FABRIC	1/48	Eduard/Hasegawa
49073	F-104G seatbelts SUPERFABRIC	1/48	Eduard/Hasegawa
49700	DB-3F/II-4	1/48	Xuntong Model
49701	Whirlwind S.A.	1/48	Trumpeter
49702	A-37A S.A.	1/48	Trumpeter
49703	P-61B rear interior S.A.	1/48	Great Wall Hobby
49704	P-61B front interior S.A.	1/48	Great Wall Hobby
49705	Me 262B-1a S.A.	1/48	Hobby Boss
49706	F-15C MSIP II S.A.	1/48	Great Wall Hobby

ZOOMS

FE701	Whirlwind interior S.A.	1/48	Trumpeter
FE700	DB-3F/II-4 S.A.	1/48	Xuntong Model
FE702	A-37A interior S.A.	1/48	Trumpeter
FE704	P-61B front interior S.A.	1/48	Great Wall Hobby
FE705	Me 262B-1a S.A.	1/48	Hobby Boss

FE706	F-15C MSIP II interior S.A.	1/48	Great Wall Hobby
33143	Do 335B interior S.A.	1/32	HKM

MASKS

EX450	P-61B	1/48	Great Wall Hobby
EX441	F-15C MSIP II	1/48	Great Wall Hobby
EX451	Me 262B-1a	1/48	Hobby Boss
JX175	Do 335B	1/32	Hong Kong Models
CX407	Bf 110C	1/72	Eduard

BIGED

BIG3347	F-104C - PART II.	1/32	Italeri
BIG49113	MiG-21R	1/48	Eduard
BIG49114	S-30M-2 FLANKER	1/48	Academy
BIG7290	C-47	1/72	Airfix
BIG7291	BLENHEIM Mk.I	1/72	Airfix

BRASSIN

648174	F-104 exhaust nozzle early	1/48	Hasegawa
648175	F-104 exhaust nozzle late	1/48	Hasegawa
648176	F-104 undercarriage wheels early	1/48	Hasegawa
648181	F-104 undercarriage wheels late	1/48	Hasegawa
672054	AGM-88 HARM	1/72	
648180	AGM-88 HARM	1/48	
648183	Spitfire Mk.V cockpit	1/48	Airfix
648184	Spitfire Mk.V radio compartment	1/48	Airfix
648188	M 117 bomb early	1/48	
632042	Do 335B wheels	1/32	Hong Kong Models

BIGSIN

SIN64817	F-104 WEAPONS SET	1/48	
----------	-------------------	------	--

DECALS

D48022	Lozenge 5-color upper
D48023	Lozenge 5-color lower

BUY / e-shop Eduard



E-BUNNY'S SQUAT

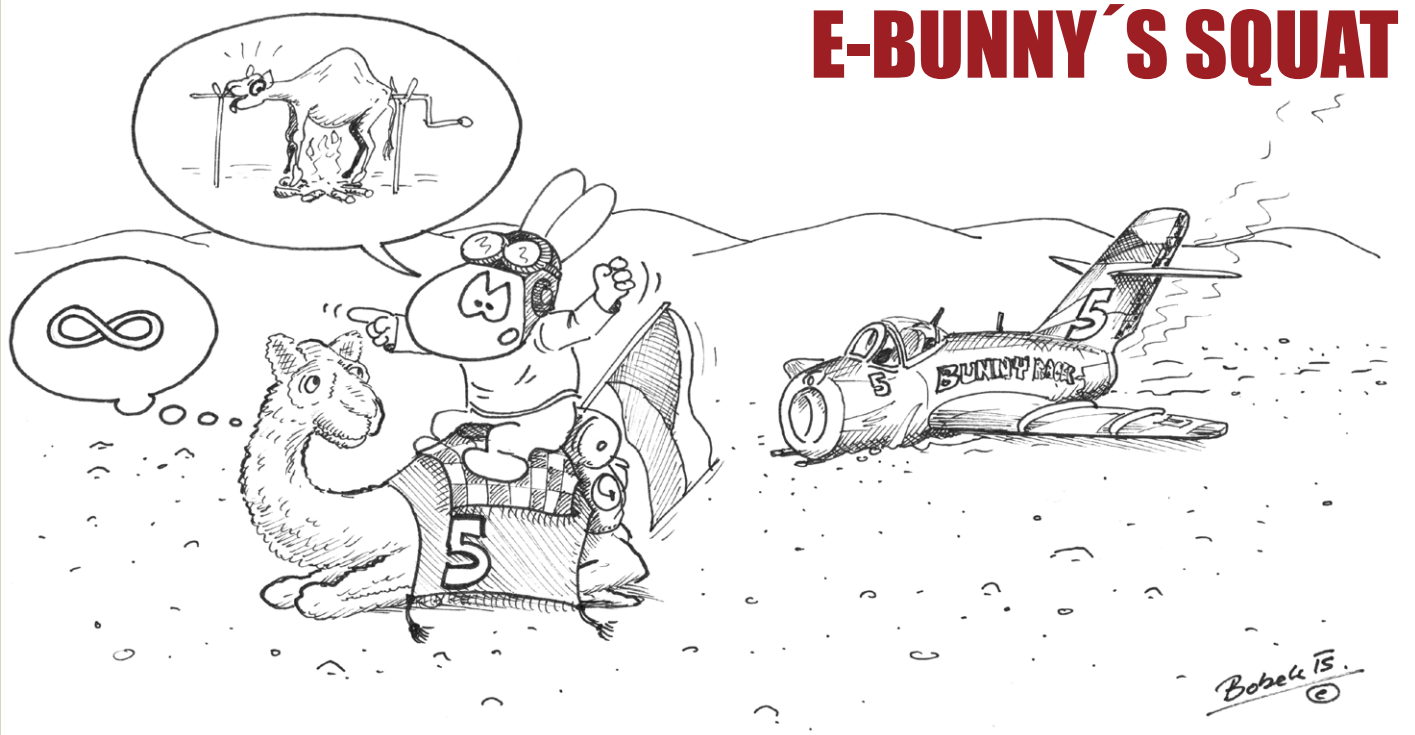

...more: article „Death of a Crocodile, Bunny Racer in Action“ (INFO 11/2014)

eduard
BRASSIN



Cat. No. 648164

AGM-12C

Bullpup B

1/48

BUY 



Cat. No. 648167

AGM-78

Standard ARM

1/48

BUY 

SSW D.III

1/48



SSW D.III, Jasta 4, Lt. Ernst Udet, Metz, October 3, 1918

Ernst Udet was photographed in the cockpit of this aircraft on October 3, 1918. He was a holder of the Pour-le-Merite and Knight's Cross, and was a 62 kill ace. But the Staffelführer of Jasta 4 never flew this aircraft in combat, and it is unlikely that he ever flew it at all. On September 26, seven DH9s of No.99 Squadron IAF attacked the

train station at Metz, and these were bounced by German aircraft on their return flight. Five of the bombers were downed over enemy territory, and two crash landed with dead gunners. Two of these kills were credited to Udet. He was wounded by a round to the thigh, and flew no more combat missions. The inscription LO! On the fuselage

also appeared on other of Udet's aircraft. It was a familiar reference to his lady friend Eleonor Zink. The extent of the red paint on the aircraft is not entirely clear from available photographs.

built by Petr Zaiřepálek



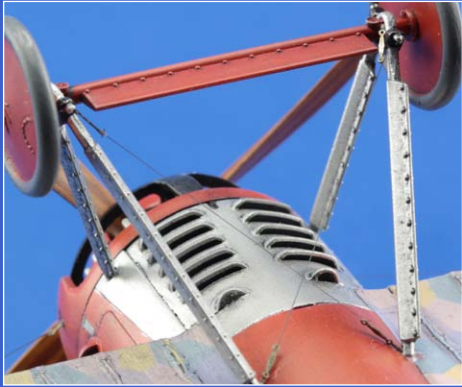

BUY SSW D.III 1/48 



ON APPROACH

BIG ED (February)

- BIG2401 TYPHOON Mk.Ib 1/24 Airfix
- BIG49115 SPITFIRE Mk.Vb 1/48 Airfix
- BIG49116 PBY-5A 1/48 Revell
- BIG7292 F-35 1/72 Hasegawa
- BIG7293 F-15C MSIP II 1/72 Academy

BRASSIN (February)

- 632047 **F-104 C2** ejection seat
1/32 Italeri
- 632048 **F-104 MB.7** ejection seat
1/32 Italeri
- 648168 **Mk.20** Rockeye II
1/48
- 648191 **B-17F/G** engines
1/48 Revell / Monogram
- 648193 **A-6** wheels
1/48 Hobby Boss
- 672049 **Mk.20** Rockeye II
1/72
- 672050 **GBU-8/B** HOBOS
1/72
- 672051 **GBU-10** Paveway I
1/72
- 672062 **MG 81** kulomet
1/72

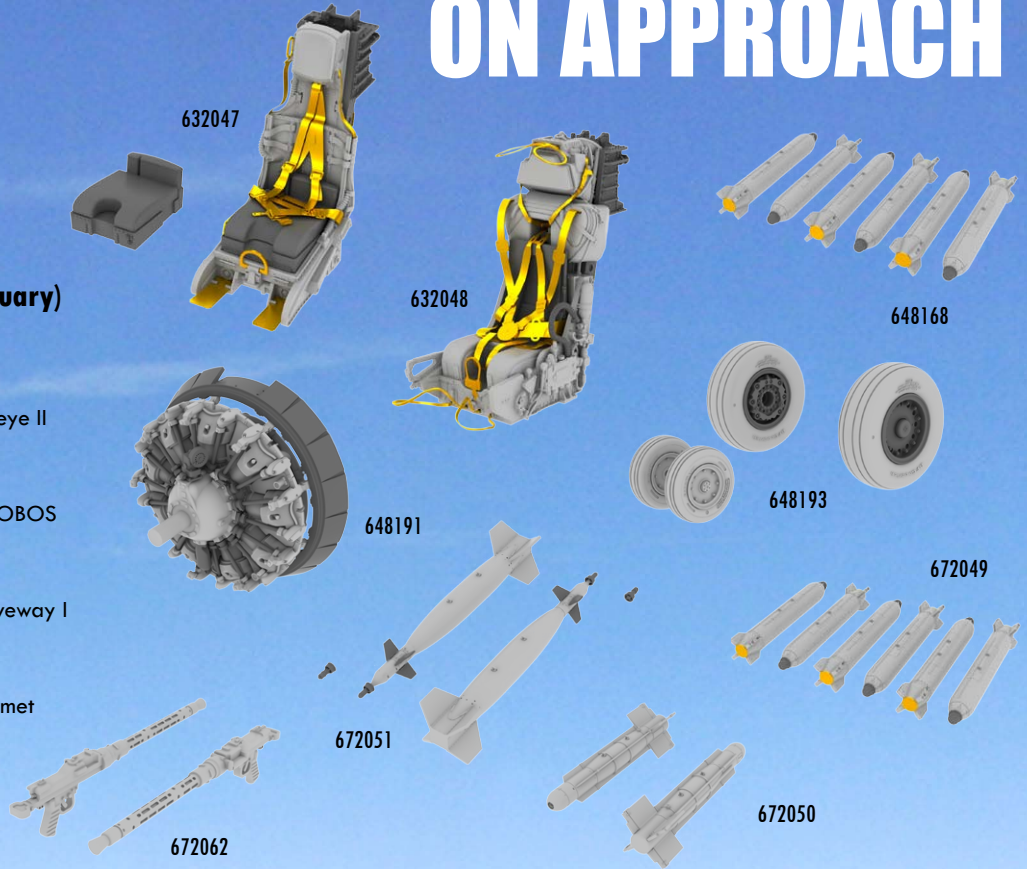

KITS (February)



R0010
AVIA B.534
1/72 Royal Class

QUATTRO COMBO



84167
Bf 109E-7 trop
1/48 Weekend



4442
MiG-15bis DUAL COMBO
1/144 SUPER44

PHOTO-ETCHED SETS (February)

PE-sets

17037	Bismarck	1/700	Revell
17038	Tirpitz	1/700	Revell
32364	Do 335 exterior	1/32	HKM
32828	F4U-1A interior S.A.	1/32	Tamiya
32365	F4U-1A engine	1/32	Tamiya
32366	F4U-1A exterior	1/32	Tamiya
32367	Wires & Stretches	1/32	
36306	Pz.Kpfw.V Panther (Ausf.D)	1/35	Zvezda
36307	Pz.Kpfw.V Panther (Ausf.D) Schürzen	1/35	Zvezda
36308	Pz.Kpfw.V Panther (Ausf.D) Zimmerit	1/35	Zvezda
36309	Jagdpanzer IV (70) Lang	1/35	Tamiya
36310	Jagdpanzer IV (70) Lang Schürzen	1/35	Tamiya
49707	Gnat T.1 S.A.	1/48	Airfix

53128	USS Hornet CV-8 part 1 - cranes	1/200	Merit
53129	USS Hornet CV-8 part 2 - radar antennas	1/200	Merit
53130	USS Hornet CV-8 part 3 - life boats	1/200	Merit
73029	Avia B.534 seatbelts SUPERFABRIC	1/72	Eduard
73521	Lightning F.6 S.A.	1/72	Airfix

ZOOMS

33144	F4U-1A interior S.A.	1/32	1/32	Tamiya
SS521	Lightning F.6 S.A.		1/72	Airfix
FE707	Gnat T.1 S.A.		1/48	Airfix
FE703	Bf 109E-7 Trop Weekend		1/48	Eduard



49707
Gnat T.1 S.A.
1/48 Airfix



49707 Gnat T.1 S.A.
1/48 Airfix



36306 Pz.Kpfw.V Panther (Ausf.D)
1/35 Zvezda



36308 Pz.Kpfw.V Panther (Ausf.D) Zimmerit
1/35 Zvezda

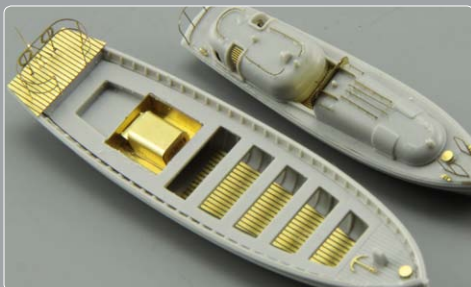

53130 USS Hornet CV-8 part 3 - life boats
1/200 Merit

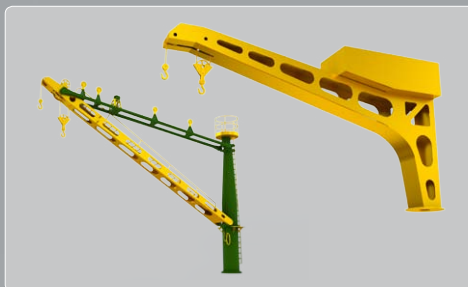

53128 USS Hornet CV-8 part 1 - cranes
1/200 Merit

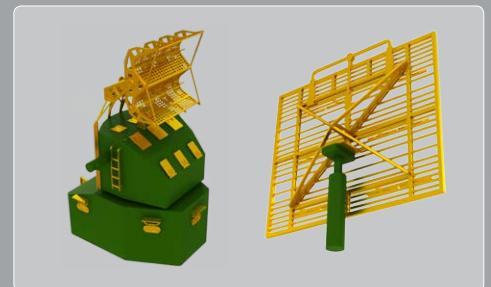

53129 USS Hornet CV-8 part 2 - radar antennas
1/200 Merit